



GMTEST4-EX

LAMPADA TEST DI IV GENERAZIONE

per rivelatore di scintille codice *GMSC243TH-EX*

Conforme alla **Direttiva ATEX 2014/34/UE**

Categoria 3D/3G

Contenitore in alluminio pressofuso verniciato RAL3000

dimensioni: B x H x P = 123 x 68 x 78mm

Temperatura di funzionamento: -30°C / +65°C

Alimentazione: 24Vdc - assorbimento: 200/250mA

Grado di protezione: IP65



GMTEST4-EX-FM

LAMPADA TEST DI IV GENERAZIONE

Certificato FM APPROVED

per rivelatore di scintille codice *GMSC243TH-EX*

Conforme alla **Direttiva ATEX 2014/34/UE**

Categoria 3D/3G

Contenitore in alluminio pressofuso verniciato RAL3000

dimensioni: B x H x P = 123 x 68 x 78mm

Temperatura di funzionamento: -30°C / +65°C

Alimentazione: 24Vdc - assorbimento: 200/250mA

Grado di protezione: IP65



DIMENSIONI:

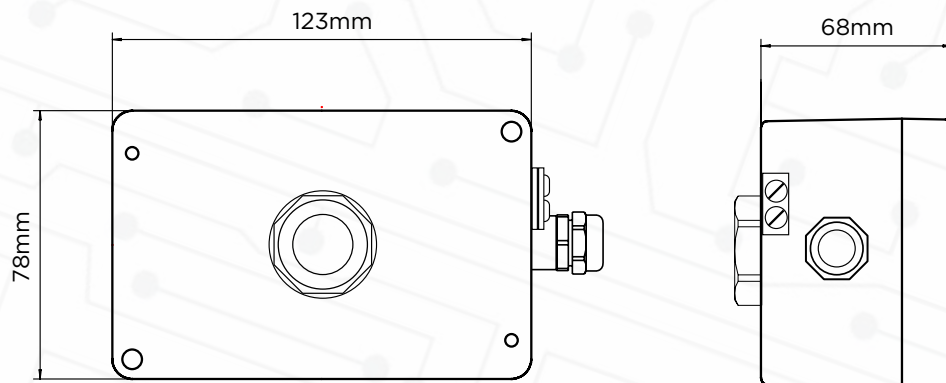

ACCESSORI:



GMSUP2-EX-TU GMSUP2-EX-TU-FM

Kit di staffaggio
su tubazione



GM-G10-008

Anello in acciaio
per permettere
la pulizia dell'obolo
del supporto.

ESEMPIO DI TEST RIVELAZIONE SCINTILLE

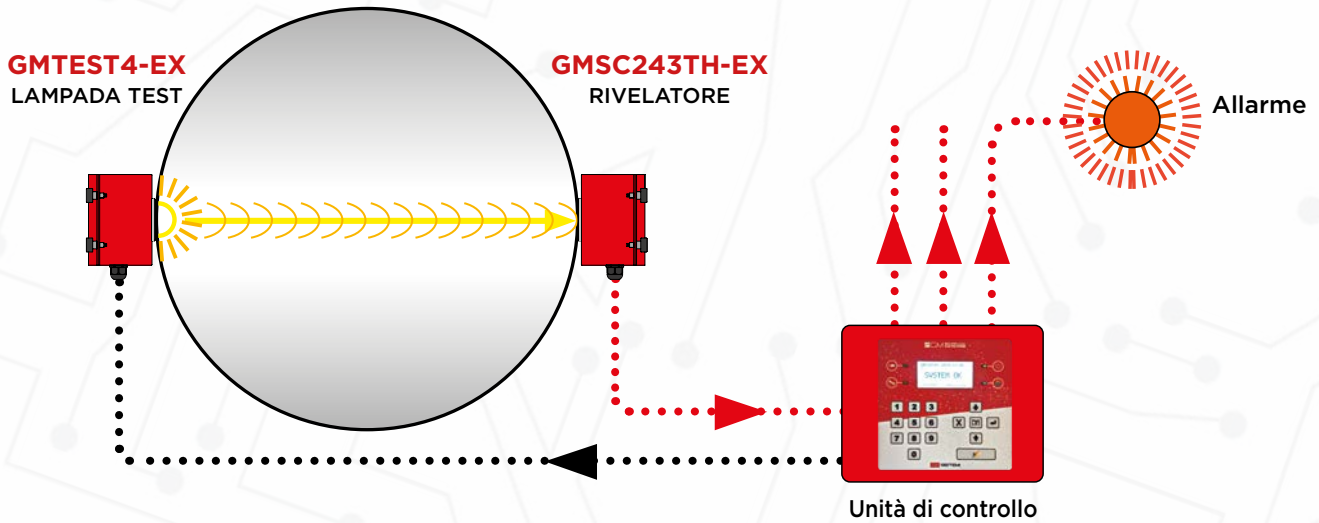

INSTALLAZIONE LAMPADE TEST E RIVELATORI SCINTILLE SU TUBAZIONI CON DIAMETRO:

MAGGIORE DI 1000mm

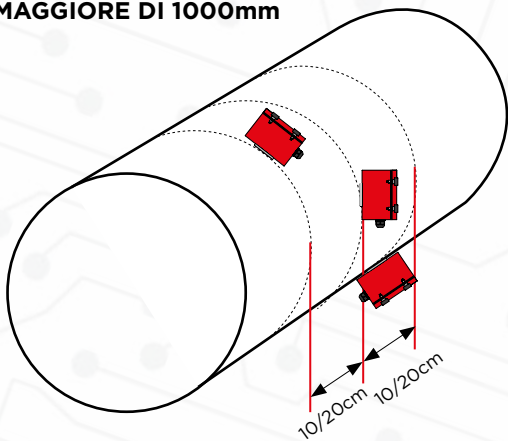

FINO A 1000mm

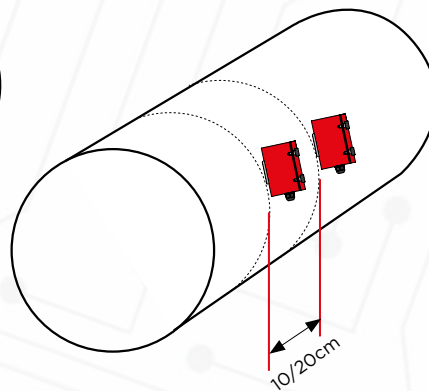

FINO A 500mm

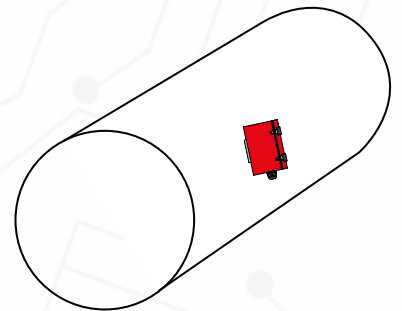

VISTA FRONTALE

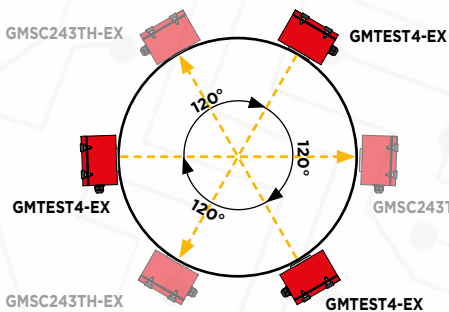

VISTA FRONTALE

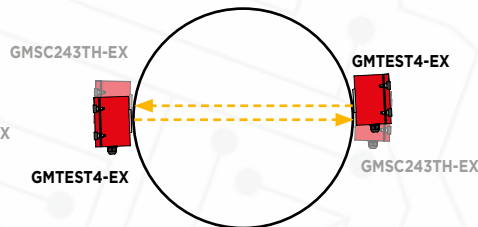

VISTA FRONTALE

